

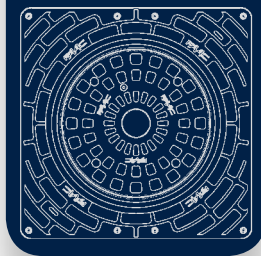

J SERIES BOLLARDS

FAAC
Simply automatic.



Bollards Series

**FAAC bollards range.
Endless solutions, performance beyond the standard**



J Series

**Innovative solutions to meet
any application need**

**FAAC Hydraulic Technology,
over 40 years of worldwide excellence**

**High quality components
to ensure exceptional performance**

**«Design for Assembly» approach; products
designed to simplify installation and
maintenance**

**The strength of the FAAC Group;
worldwide presence to support
your project**

Solutions for vehicle traffic control in residential, commercial, industrial and urban areas with limited traffic and for perimeter protection security applications.



J200 Series for residential areas

(HA) Automatic

To regulate vehicle access to residential areas

(F) Fixed

To complete installations with other retractable models for access control



J275 Series for commercial, industrial and urban restricted access areas

(HA) Automatic

To regulate vehicular access to commercial, industrial and urban restricted access areas

(SA) Semi-Automatic

To regulate vehicle access to town centres, areas that are difficult to wire or occasionally open to traffic

(F) Fixed

To complete installations with other retractable models for access control



J355 M30-P1 Series certified perimeter security

(HA) Automatic

To define, protect and regulate vehicle access to sensitive areas (embassies, military areas, etc.) and, in general, to sites with special security requirements





Bollards for residential areas J200

1. J200HA AUTOMATIC

RETRACTABLE TRAFFIC BOLLARD

The Automatic retractable traffic bollard FAAC J200HA is particularly suitable to regulate vehicle traffic in residential areas, ensuring an intelligent control, while maintaining the aesthetic appearance.

2. J200F FIXED TRAFFIC BOLLARD

The Fixed traffic bollard FAAC J200 does not require invasive installation work, nor electrical wiring. It is therefore ideal for permanent installations to define residential pedestrian areas, or for mixed installations which also feature other automatic or semi-automatic bollards.

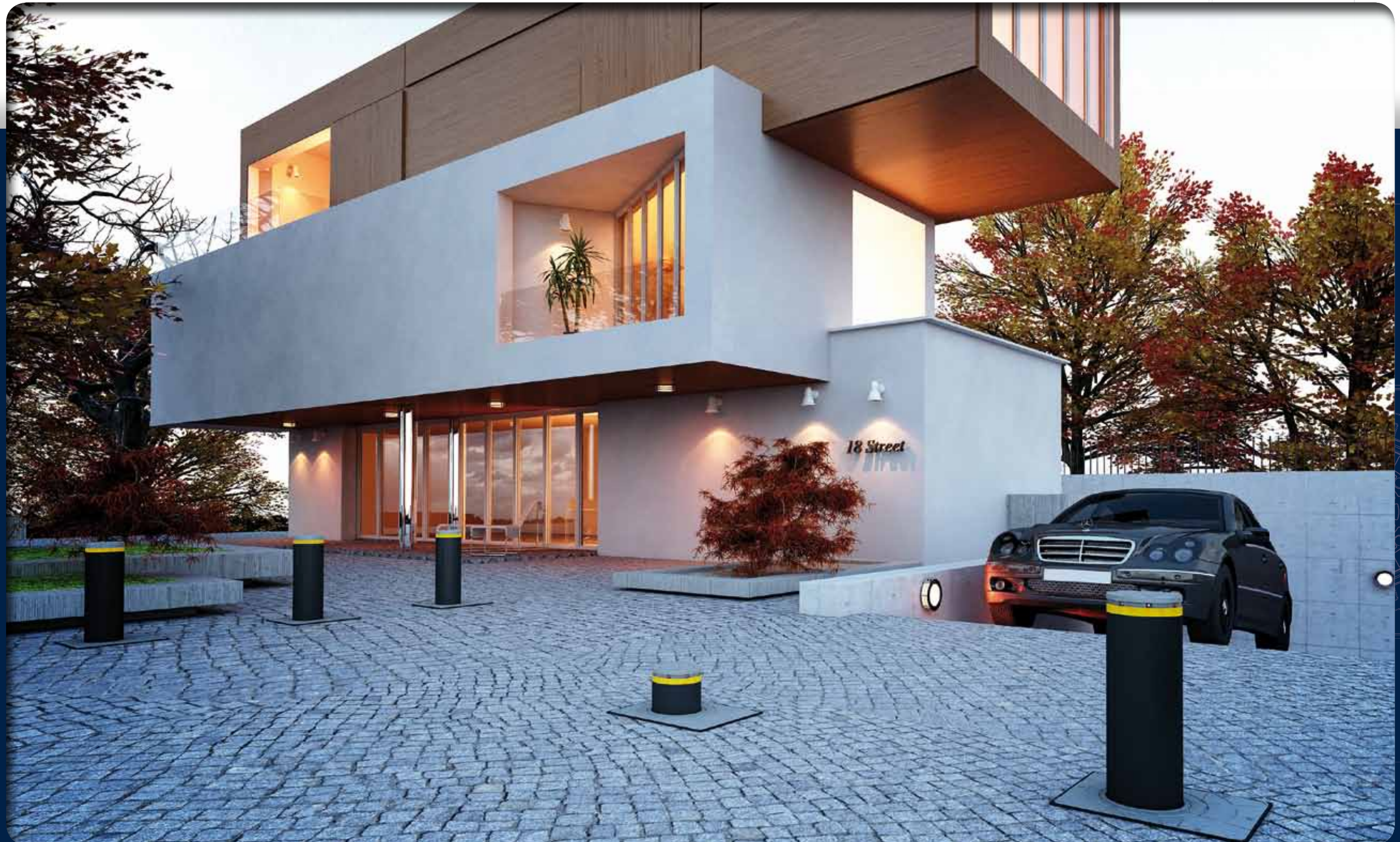

J200



J200HA AUTOMATIC retractable traffic bollard

1. Easy to transport, store and install, thanks to the self-supporting structure - pit not required - and to the limited weight of the product
2. A streamlined product, configurable by selecting the desired installation accessories
3. Simplified maintenance (possible with just one person)
4. Fast and silent movement



DIMENSIONS AND TECHNICAL SPECIFICATIONS

Drive	Hydraulic Actuator
Cylinder stroke	600 mm
Cylinder diameter	200 mm
Cylinder material standard version	Steel Fe 360 (6 mm thickness)
Standard cylinder surface treatment	Cataphoresis and polyester powder paint, dark grey metallised RAL 7021
Cylinder material special stainless steel version	Satin-finished AISI 316 (6 mm thick)
Cylinder top part (head)	Aluminium RAL 9006
Rise time	About 7 sec
Descent time	About 7 sec
Hydraulic pump power supply	230 Vac +6% - 10%; 50/60 Hz
Power consumption	230 W
Protection rating	IP 56
Recommended Use	Use in Residential areas
Standard refracting strip	Height 25 mm
Manual lowering operation	Possible with hydraulic circuit mechanical release
Total weight	90 kg
Operating temperature	-15 °C / +55 °C
Operating temperature with heater (opt.)	-25 °C / +55 °C
Dimensions	400x500x800 mm
Connection cable	Standard 16+1 conductors, minimum section 1.5 mm (not supplied)
Maximum length	50 m

STANDARD VERSIONS IN PAINTED STEEL

Models	Height	Finish	Item code
J200 HA 600	600 mm	Painted steel	116500

The product comes with:

- 5 mm thick steel cylinder with cataphoresis treatment and painted
- powder coated dark grey metallised RAL 7021
- hydraulic lock in raised position (in the event of a power cut) with special release key
- support structure to be cemented with cataphoresis treatment (pits not required)

STANDARD VERSIONS IN AISI 316 STAINLESS STEEL

Models	Height	Finish	Item code
J200 HA 600	600 mm	Satin-finished AISI 316 stainless steel	116505





The product comes with:

- 5 mm thick stainless steel cylinder with satin-finish treatment
- hydraulic lock in raised position (in the event of a power cut) with special release key
- support structure to be cemented with cataphoresis treatment (pits not required)

ELECTRONIC EQUIPMENT

Item	Item code	
Bollard electronic board JE275 able to manage up to four bollards J200 HA	116300	

OPTIONAL ACCESSORIES

Item	Item code	
Pit heater J200HA	116501	
Release kit with pressure switch for J200HA	116502	
Acoustic buzzer J200HA	116503	
LED lights kit J200HA	116504	

500

J200HA



J200F FIXED traffic bollard

1. Power supply and wiring not required
2. Simple installation and limited digging operations
3. Observance of aesthetic consistency in mixed installations with other retractable bollards
4. Easy to transport, store and install, thanks to the limited weight of the product

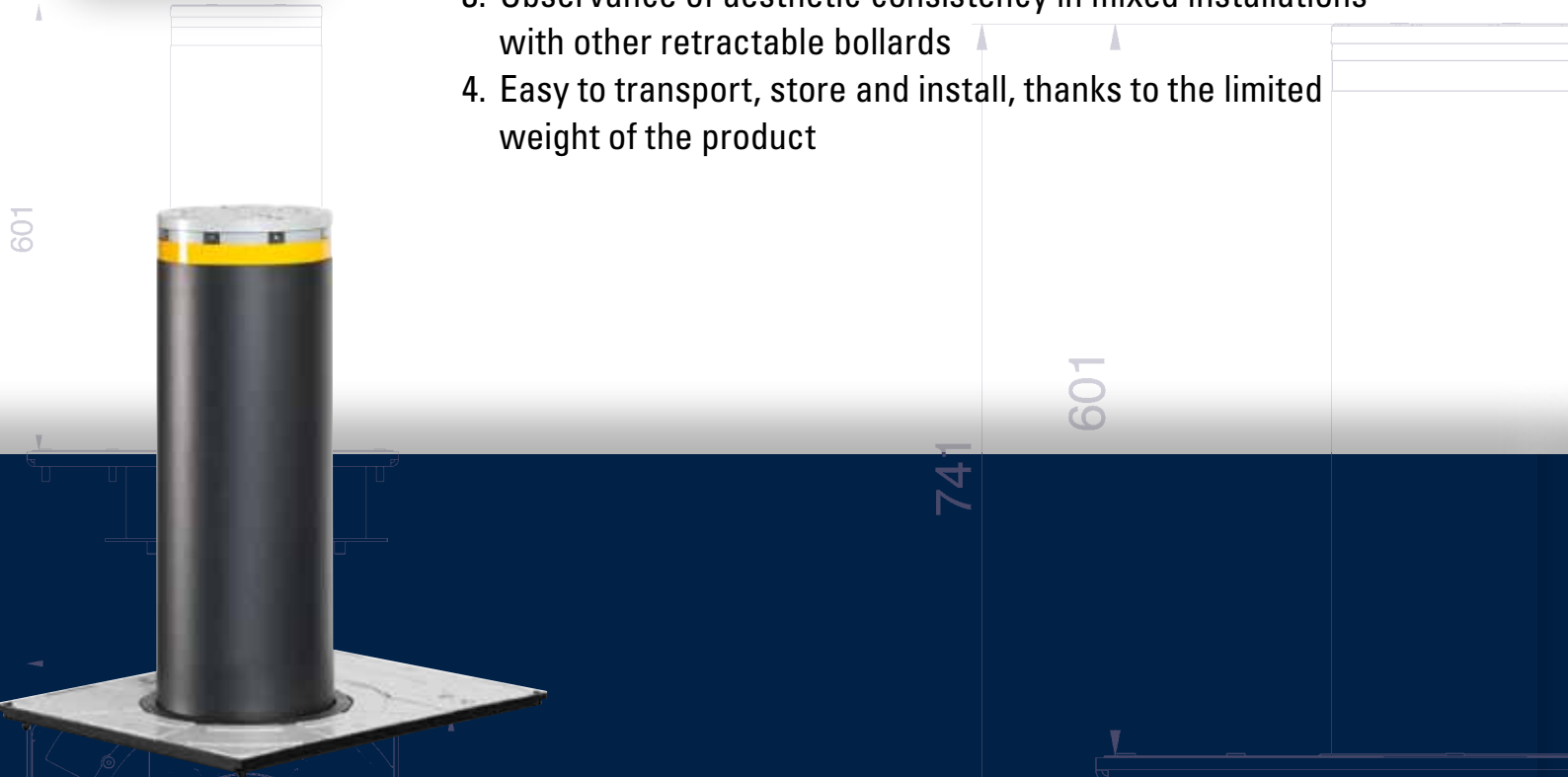

STANDARD VERSIONS IN PAINTED STEEL

Models	Height	Finish	Item code
J200 F 600	600 mm	Painted steel	116506

The product comes with:

- 5 mm thick steel cylinder with cathoresis treatment and painted
- powder coated dark grey metallised RAL 7021
- support structure to be cemented with cathoresis treatment (pits not required)

STANDARD VERSIONS IN AISI 316 STAINLESS STEEL

Models	Height	Finish	Item code
J200 F 600	600 mm	Satin-finished AISI 316 stainless steel	1165067

The product comes with:

- 5 mm thick stainless steel cylinder with satin-finished treatment
- support structure to be cemented with cathoresis treatment (pits not required)

DIMENSIONS AND TECHNICAL SPECIFICATIONS

Cylinder height	600 mm
Cylinder diameter	200 mm
Cylinder material standard version	Steel Fe 360 (6 mm thickness)
Standard cylinder surface treatment	Cathoresis and polyester powder paint, dark grey metallised RAL 7021
Cylinder material special stainless steel version	Satin-finished AISI 316 (6 mm thick)
Cylinder top part (head)	Aluminium RAL 9006
Standard refracting strip	Height 25 mm

OPTIONAL ACCESSORIES

Item	Item code
LED lights kit J200HA	116504



J200F

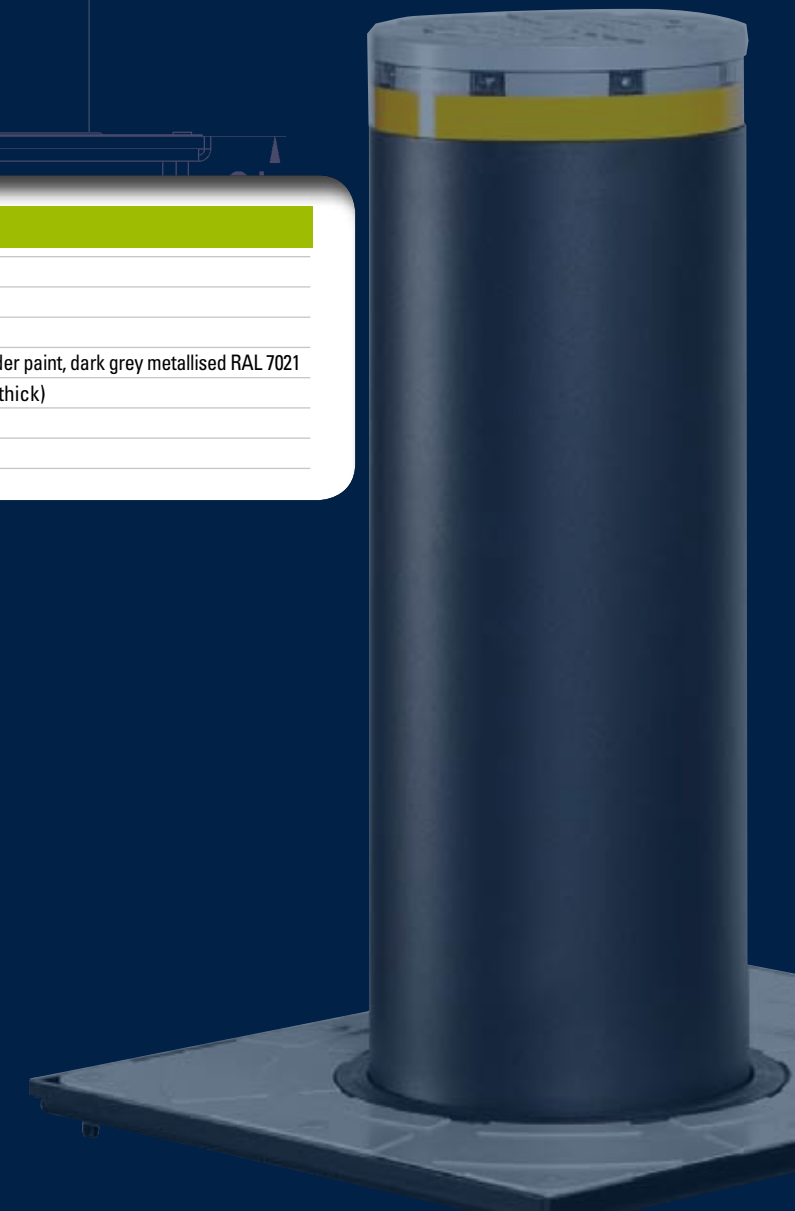

400

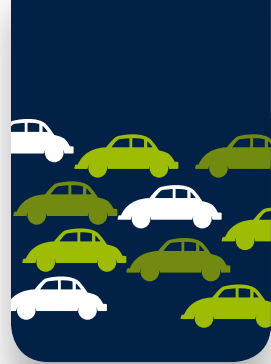

Bollards for commercial, industrial and urban restricted access areas J275

Bollards J275 for the regulation of vehicle traffic within commercial areas, industrial areas and to manage urban restricted access areas

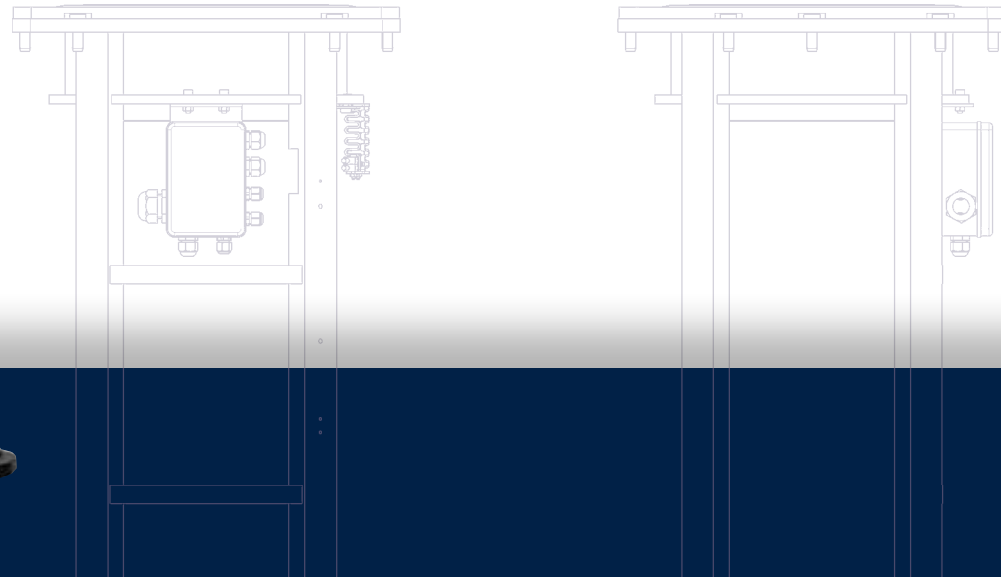

J275

1. J275HA AUTOMATIC RETRACTABLE TRAFFIC BOLLARD

The Automatic retractable traffic bollard J275HA is recommended for all areas when many daily transits are expected, i.e. commercial, industrial and urban restricted access areas.

2. J275SA SEMI-AUTOMATIC RETRACTABLE TRAFFIC BOLLARD

The Semi-Automatic retractable traffic bollard J275SA is particularly suitable for town centres and areas difficult to wire.

In fact, thanks to a gas actuator, raising and lowering is fully mechanical and does not require any electrical connection.

3. J275F FIXED TRAFFIC BOLLARD

The Fixed traffic bollard FAAC J275 does not require invasive installation work, nor electrical wiring. It is therefore ideal for permanent installations to define pedestrian areas, or for mixed installations which also feature other retractable bollards.

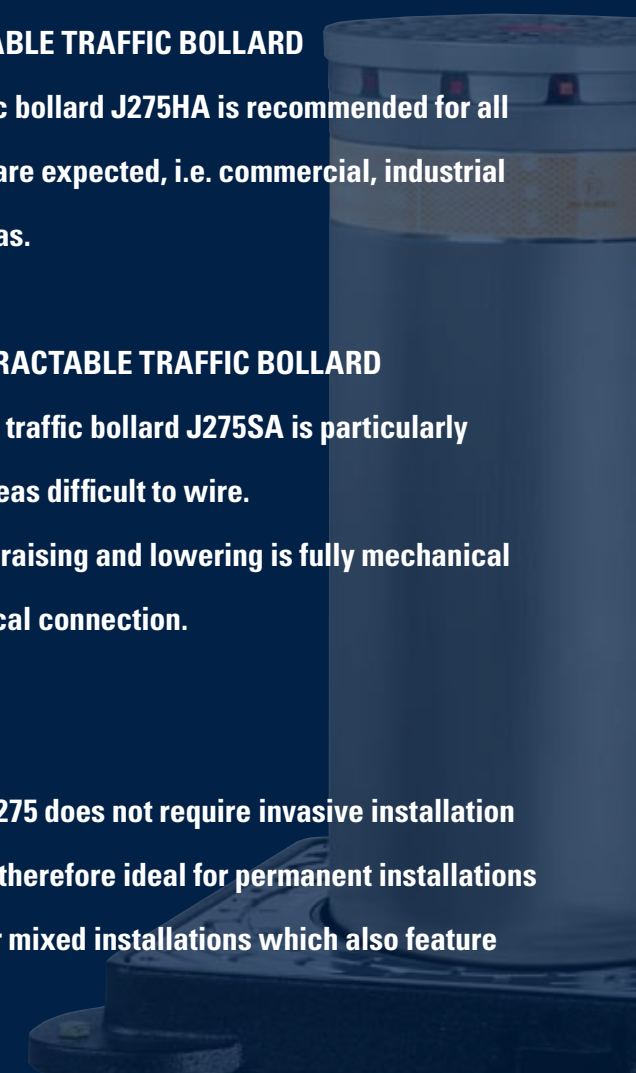



J275HA AUTOMATIC retractable traffic bollard

1. Guaranteed for high frequency use
2. "Full optional" product; supplied equipped with the main accessories
3. Extreme care in the selection of materials
4. Simplified maintenance (possible with just one person)
5. Perfect interchangeability with first generation bollards
6. Fast and silent movement



STANDARD VERSIONS IN PAINTED STEEL

Models	Height	Finish	Item code
J275 HA 600	600 mm	painted steel	116000
J275 HA 800	800 mm		116001

The product comes with:

- 7 mm thick steel cylinder with cataphoresis treatment and painted
- powder paint, dark grey metallised RAL 7021
- flashing light ring with central LED
- acoustic movement buzzer
- emergency lowering in the event of a power cut (can be excluded)

STANDARD VERSIONS IN AISI 316 STAINLESS STEEL

Models	Height	Finish	Item code
J275 HA 600	600 mm	satin-finished AISI 316 stainless steel	116030
J275 HA 800	800 mm		116031

The product comes with:

- 6 mm thick stainless steel cylinder with satin-finished treatment
- flashing light ring with central LED
- acoustic movement buzzer
- emergency lowering in the event of a power cut (can be excluded)



DIMENSIONS AND TECHNICAL SPECIFICATIONS

	Hydraulic Actuator	
	600 mm	800 mm
Drive	Hydraulic Actuator	
Cylinder stroke	600 mm	800 mm
Cylinder diameter	275 mm	
Cylinder material standard version	Steel Fe 360 (7 mm thickness)	
Standard cylinder surface treatment	Cataphoresis and polyester powder paint, dark grey metallised RAL 7021.	
Cylinder material special stainless steel version	Satin-finished AISI 316 (6 mm thickness)	
Cylinder top part (head)	Aluminium RAL 9006	
Rise time	About 5 sec	About 7 sec.
Descent time (standard)	About 2.8 sec	About 3.5 sec
Descent time (rapid) (*)	ABOUT 1 SEC	ABOUT 1.2 SEC
Hydraulic pump power supply	230 Vac +6% - 10%; 50/60 Hz	
Power consumption	220 W	
Protection rating	IP 56	
Recommended use	Intensive use (Traffic)	
Standard refracting strip	Height 55 mm	
Manual lowering operation	Possible with hydraulic circuit mechanical release	
Impact resistance	38 KJoules/painted steel - 67 KJoules/stainless steel	
Break-in resistance	128 KJoules/painted steel - 207 KJoules/stainless steel	
Total weight	112kg (diss.) + 55kg (pit)	130kg (diss.) + 65kg (pit)
Operating temperature	-15 °C / +55 °C	
Operating temperature with heater (optional)	-25 °C / +55 °C	
Pit to be walled in with modular cylinder profile	560x560x950 mm	560x560x1,220 mm
Connection cable	Standard 16+1 conductors, minimum section 1,5 mm (not supplied)	
Maximum length	50 m	

ELECTRONIC EQUIPMENT



Item	Item code	
Bollard electronic board JE275 able to manage up to four bollards J275 HA	116300	

INSTALLATION ACCESSORIES

Item	Item code	
Pit JP 275/600 for bollard H600 complete with counter frame	116100	
Pit extension JP 275/800* for bollard H800*	1161001	

(*) For the 800 mm version the following two elements must be ordered: 116100 + 116101.

OPTIONAL ACCESSORIES

Item	Item code	
Pit heater JH275 (to extend operation up to -25°C)	116200	
Pit cover JC275	116201	

J275HA



J275SA SEMI-AUTOMATIC retractable traffic bollard

1. Power supply and wiring not required
2. Simple and safe movement, thanks to the specific release key
3. "Full optional" product; supplied equipped with the main accessories
4. Low position lock guaranteed against accidental release
5. Extremely simple maintenance



STANDARD VERSIONS IN PAINTED STEEL

Models	Height	Finish	Item code
J275 SA 600	600 mm	powder paint, dark grey metallised RAL 7021	116050

The product comes with:

- 7 mm thick steel cylinder with cataphoresis treatment and painted
- powder paint, dark grey metallised RAL 7021
- flashing light ring with central LED
- mechanical lock in raised position with special release key (2 release keys supplied as standard)

STANDARD VERSIONS IN AISI 316 STAINLESS STEEL

Models	Height	Finish	Item code
J275 SA 600	600 mm	satin-finished AISI 316 stainless steel	116060

The product comes with:

- 6 mm thick stainless steel cylinder with satin-finished treatment
- flashing light ring with central LED*
- mechanical lock in raised position with special release key (2 release keys supplied as standard)

(*) The power supply unit (24 Vdc) and the cable (2x1.5 mm) for the illuminated ring are not supplied.

DIMENSIONS AND TECHNICAL SPECIFICATIONS

Drive	Single-acting gas actuator
Cylinder stroke	600 mm
Cylinder diameter	275 mm
Cylinder material standard version	Steel Fe 360 (7 mm thickness)
Standard cylinder surface treatment	Cataphoresis and polyester powder paint, dark grey metallised RAL 7021
Cylinder material special stainless steel version	Satin-finished AISI 316 (6 mm thickness)
Cylinder top part (head)	Aluminium RAL 9006
Rise	Key release for automatic rise, with gas actuator
Descent	Key release for lowering, with pressure on the top of the cylinder
Standard refracting strip	Height 55 mm
Impact resistance	38 KJoules/painted steel - 67 KJoules/stainless steel
Break-in resistance	128 KJoules/painted steel - 207 KJoules/stainless steel
Total weight	70kg (bollard) + 55kg (pit)
Pit to be walled in with modular cylinder profile	560x560x950 mm

INSTALLATION ACCESSORIES

Item	Item code	
Pit JP 275/600 for bollard H600 complete with counter frame	116100	

OPTIONAL ACCESSORIES

Item	Item code	
Release keys kit (5 keys)	390084	
Pit cover JC275	116201	

J275SA



J275F FIXED traffic bollard

1. Power supply and wiring not required
2. Simple installation and limited digging operations
3. Observance of aesthetic consistency in mixed installations with other retractable bollards
4. Possibility to remove the bollard to temporarily open the pedestrian area to traffic



DIMENSIONS AND TECHNICAL SPECIFICATIONS

Cylinder height	600 mm	800 mm
Cylinder diameter	275 mm	
Cylinder material standard version	Steel Fe 360 (4 mm thickness)	
Standard cylinder surface treatment	Cataphoresis and polyester powder paint, dark grey metallised RAL 7021	
Cylinder material special stainless steel version	Satin-finished AISI 316 (3 mm thick)	
Cylinder top part (head)	Aluminium RAL 9006	
Standard refracting strip	Height 55 mm	
Break-in resistance	35 KJoules/painted steel -59 KJoules/stainless steel	
Total weight	34 kg (bollard)	38 kg (bollard)
Frame to be walled in	450 x 450 x 30 mm	

STANDARD VERSIONS IN PAINTED STEEL

Models	Height	Finish	Item code
J275 F 600	600 mm	painted steel	116020
J275 F 800	800 mm		116021

The product comes with:

- a 4 mm steel cylinder cataphoresis treated and painted
- powder coated dark grey metallised RAL 7021
- flashing light ring with central LED*

STANDARD VERSIONS IN AISI 316 STAINLESS STEEL

Models	Height	Finish	Item code
J275 F 600	600 mm	satin-finished AISI 316 stainless steel	116040
J275 F 800	800 mm		116041

The product comes with:

- 3 mm thick stainless steel cylinder with satin-finished treatment
- flashing light ring with central LED*

(*) The power supply unit (24 Vdc) and the cable (2x1.5 mm) for the illuminated ring are not supplied.

INSTALLATION ACCESSORIES

Item	Item code
Fixed bollard fixing frame JPF275	116120



OPTIONAL ACCESSORIES

Item	Item code
Pit cover JC275	116201



J275F



J355HA-M30-P1 bollard certified for use in perimeter security areas

The AUTOMATIC bollard FAAC J355HA-M30-P1 is designed and tested for the protection of sensitive areas such as airports, embassies, consulates, banks, ports, etc.

The bollard FAAC J355HA-M30-P1 has been tested according to American Standard "ASTM F 2656-07 - Standard Test Method for Vehicle Crash Testing of Perimeter Barriers", obtaining certification for the highest class of penetration possible. Classification M30-P1 indicates in fact that the bollard FAAC J355 is able to stop a 6,800 kg lorry travelling at 50Km/h (=30M/h) with just 1 metre of total penetration (P1).



J355HA



J355HA-M30-P1 bollard certified for use in perimeter security areas

1. CERTIFIED according to Standard ASTM F 2656-07 M30
2. "Full optional" product; supplied equipped with the main accessories
3. Lock in raised position guaranteed even in the event of a power cut
4. Extreme care in the selection of materials
5. Also available in the EFO (Emergency Fast Operation) version for very fast rise



STANDARD VERSIONS IN PAINTED STEEL

Models	Height	Finish	Item code
J355 HA M30-P1	1,000 mm	painted steel	116002
J355 HA M30-P1 EFO			116003

The product comes with:

- 16 mm thick steel cylinder with cataphoresis treatment and painted
- powder coated dark grey metallised RAL 7021
- flashing light ring with central LED
- hydraulic lock in raised position (in the event of a power cut)
- watertight galvanised steel pit with connection for recovery of fluids
- emergency circuit for fast rise (EFO version only)

STANDARD VERSIONS IN AISI 316 STAINLESS STEEL

Models	Height	Finish	Item code
J355 HA M30-P1	1,000 mm	satin-finished AISI 316 stainless steel	116032
J355 HA M30-P1 EFO			116033

The product comes with:

- 16 mm thick steel cylinder with cataphoresis treatment and satin-finished stainless steel «sleeve»
- flashing light ring with central LED
- hydraulic lock in raised position (in the event of a power cut)
- watertight galvanised steel pit with connection for recovery of fluids
- emergency circuit for fast rise (EFO version only)

DIMENSIONS AND TECHNICAL SPECIFICATIONS

Drive	Hydraulic Actuator
Cylinder stroke	1,000 mm
Cylinder diameter	355 mm
Cylinder material	Steel S355JR EN10210 (16 mm thickness)
Cylinder surface treatment	Cataphoresis and polyester powder paint, dark grey metallised RAL 7021
Sleeve material (stainless steel special vers.)	Satin-finished AISI 316
Cylinder top part (head)	Aluminium RAL 9006
Rise time	About 6 sec/standard version - About 1.5 sec/EFO version
Descent time (standard)	About 2 sec
Hydraulic pump power supply	230 Vac +6% - 10%; 50/60 Hz
Power consumption	1,200 W
Maximum expressed force	5,000 N
Junction box protection rating	IP 66
Recommended Use	Use in security areas
Standard refracting strip	Height 55 mm
Impact resistance	150 Kjoules
Break-in resistance	656 KJoules (in compliance with Standards ASTM F2656-07 - M30)
Load class	C25 (25t)
Total weight	490 kg (bollard) + 250 kg (pit)
Operating temperature	-15 °C / +55 °C
Operating temperature with heater (optional)	-40 °C / +55 °C
Pit to be walled in	570x690x1665 mm
Connection cable	Standard 16+1 conductors, minimum section 1,5 mm (not supplied)
Maximum length	50 m

ELECTRONIC EQUIPMENT

Item	Item code	
Bollard electronic board JE275 able to manage up to max 1 bollard J355 M30-P1	116300	

INSTALLATION ACCESSORIES

Item	Item code	
Pit heater J355	116202	
Manual release key	116102	

J355HA



J200 SERIES

DIAMETER	200 mm
HEIGHT	600 mm
FINISH	PAINTED STEEL, SATIN-FINISHED STAINLESS STEEL
VERSIONS	AUTOMATIC (HA); FIXED (F)



J275 SERIES

DIAMETER	275 mm
HEIGHT	600 mm - 800 mm
FINISH	PAINTED STEEL, SATIN-FINISHED STAINLESS STEEL
VERSIONS	AUTOMATIC (HA); SEMI-AUTOMATIC (SA); FIXED (F)



J355 SERIES

DIAMETER	355 mm
HEIGHT	1,000 mm
FINISH	PAINTED STEEL, SATIN-FINISHED STAINLESS STEEL
VERSIONS	AUTOMATIC (HA); AUTOMATIC + EMERGENCY FAST OPERATION (HA EFO)



HEADQUARTERS

ITALY

FAAC SpA
Via Calari 10 - 40069 Zola Predosa (BO)
Tel. +39 051 61724 - Fax +39 051 758518
it.info@faacgroup.com - www.faacgroup.com

SUBSIDIARIES

AUSTRALIA

FAAC AUSTRALIA PTY LTD
Homebush – Sydney, Australia
tel. +61 2 87565644
fax +61 2 87565677
www.faac.com.au

AUSTRIA

FAAC GMBH
Salzburg, Austria
tel. +43 662 8533950
fax +43 662 85339525
www.faac.at

FAAC TUBULAR MOTORS

tel. +49 30 56796645
fax +49 30 22409006
faactm.info@faacgroup.com
www.faac.at

BENELUX

FAAC BENELUX NV/SA
Brugge, Belgium
tel. +32 50 320202
fax +32 50 320242
www.faacbenelux.com

FAAC TUBULAR MOTORS

Schaapweg 30
NL-6063 BA Vlodrop, Netherlands
tel. +31 475 406014
fax +31 475 406018
faactm.info@faacgroup.com
www.faacbenelux.com

CHINA

FAAC SHANGHAI
Shanghai, China
tel. +86 21 68182970
fax +86 21 68182968
www.faacgroup.cn

FRANCE

FAAC FRANCE
Saint Priest - Lyon, France
tel. +33 4 72218700
fax +33 4 72218701
www.faac.fr

FAAC FRANCE - AGENCE PARIS

Massy - Paris, France
tel. +33 1 69191620
fax +33 1 69191621
www.faac.fr

FAAC FRANCE - DEPARTEMENT VOLETS

Saint Denis de Pile - Bordeaux, France
tel. +33 5 57551890
fax +33 5 57742970
www.faac.fr

GERMANY

FAAC GMBH
Freilassing, Germany
tel. +49 8654 49810
fax +49 8654 498125
www.faac.de

FAAC TUBULAR MOTORS

tel. +49 30 56796645
fax +49 30 22409006
faactm.info@faacgroup.com
www.faac.de

INDIA

FAAC INDIA PVT. LTD
Noida – Delhi, India
tel. +91 120 3934100/4199
fax +91 120 4212132
www.faacindia.com

IRELAND

NATIONAL AUTOMATION LTD
Co. Roscommon, Ireland
tel. +353 71 9663893
fax: +353 71 9663890
www.nal.ie

MIDDLE EAST

FAAC MIDDLE EAST FZE
Dubai Silicon Oasis Operation Center - Dubai, UAE
tel. + 971 4 3724190
fax+ 971 4 3724191
www.faac.ae

NETHERLANDS

KEMKO BV
Doetinchem, Netherlands
tel. +31 314 378777
fax +31 314 362224
www.kemko.nl

NORDIC REGIONS

FAAC NORDIC AB
Perstorp, Sweden
tel. +46 435 779500
fax +46 435 779529
www.faac.se

POLAND

FAAC POLSKA SP.ZO.O
Warszawa, Poland
tel. +48 22 8141422
fax +48 22 8142024
www.faac.pl

RUSSIA

FAAC RUSSIA
Moscow, Russia
tel. +7 (495) 646 24 29
www.faac.ru

SPAIN

CLEM, S.A.U.
San Sebastián de los Reyes - Madrid, Spain
tel. +34 91 3581110
fax +34 91 7293309
www.faac.es

SWITZERLAND

FAAC AG
Altdorf, Switzerland
tel. +41 41 8713440
fax + 41 41 8713484
www.faac.ch

TURKEY

FAAC OTOMATİK GEÇİŞ SİSTEMLERİ LTD. ŞTİ.
SAN. VE TİC. LTD. ŞTİ.
İstanbul, Turkey
tel.+90 (0)212 - 3431311
www.faac.com.tr

UNITED KINGDOM

FAAC UK LTD.
Basingstoke - Hampshire, UK
tel. +44 1256 318100
fax +44 1256 318101
www.faac.co.uk

U.S.A.

FAAC INTERNATIONAL INC
Jacksonville, FL - U.S.A.
tel. +1 904 4488952
fax +1 904 4488958

FAAC INTERNATIONAL INC
Fullerton, California - U.S.A.
tel. +1 714 446 9800
fax +1 714 446 9898
www.faacusa.com

FAAC
Simply automatic.

